

Contour Gen 2 Flex

LED Lighting System

24
Volt

Side Bend

GEXNFS32-1, GEXNFS65-1, GEXNFSRD-1,
 GEXNFSGL-1, GEXNFSBL-1, GEXNFSYG-1,
 GEXNFSRC-1

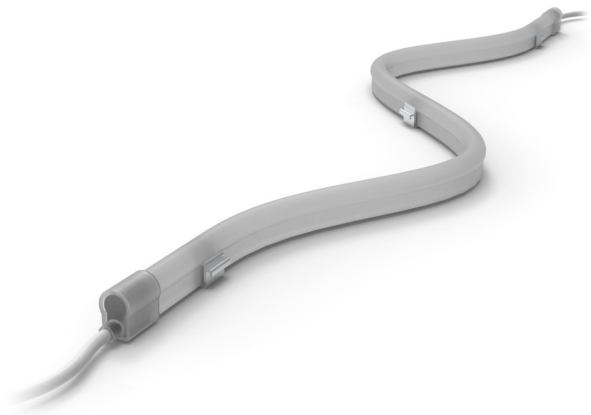

BEFORE YOU BEGIN

Read these instructions completely and carefully.

- | | | |
|--|---|--|
| <p>BG Българската версия на инструкциите за инсталация и информация за безопасност могат да бъдат намерени на следния адрес: https://products.gecurrent.com/eu/led-signage-lighting</p> <p>CS Návod k montáži a bezpečnostní informace v češtině najdete zde: https://products.gecurrent.com/eu/led-signage-lighting</p> <p>DA Den danske version af installationsvejledningen og sikkerhedsoplysninger kan findes på følgende placering: https://products.gecurrent.com/eu/led-signage-lighting</p> <p>DE Die deutsche Version der Installationsanleitung und Sicherheitsinformationen finden Sie in folgendem Verzei: https://products.gecurrent.com/eu/led-signage-lighting</p> <p>EL Μπορείτε να βρείτε την ελληνική εκδοχή των οδηγιών εγκατάστασης και των πληροφοριών ασφαλείας στην εξής τοποθεσία: https://products.gecurrent.com/eu/led-signage-lighting</p> <p>ES La versión española de las instrucciones de instalación y la información sobre seguridad puede encontrarse en la siguiente ubicación: https://products.gecurrent.com/eu/led-signage-lighting</p> <p>ET Eestikeelse paigaldusjuhendi ja ohutusnõuded leiate aadressilt: https://products.gecurrent.com/eu/led-signage-lighting</p> | <p>FI Asennusohjeiden ja turvallisuustietojen suomenkielinen versio löytyy seuraavasta paikasta: https://products.gecurrent.com/eu/led-signage-lighting</p> <p>FR La version française des instructions d'installations et information de sécurité est disponible à l'adresse suivante: https://products.gecurrent.com/eu/led-signage-lighting</p> <p>HR Hrvatska verzija priručnika za ugradnju i sigurnosnih informacija nalazi se na sljedećoj lokaciji: https://products.gecurrent.com/eu/led-signage-lighting</p> <p>HU A telepítési útmutató és a biztonsági információk magyar nyelvű változata az alábbi címen található: https://products.gecurrent.com/eu/led-signage-lighting</p> <p>IT La versione italiana del manuale di installazione e sicurezza può essere reperita nella seguente sezione: https://products.gecurrent.com/eu/led-signage-lighting</p> <p>LT Lietuvišką diegimo instrukcijos ir saugos informacijos versiją galima rasti šioje vietoje: https://products.gecurrent.com/eu/led-signage-lighting</p> <p>LV Uzstādīšanas instrukciju un drošības informāciju latviešu valodā var atrast šeit: https://products.gecurrent.com/eu/led-signage-lighting</p> <p>NL De Nederlandse versie van de installatie-instructies en veiligheidsinformatie kan op de volgende locatie worden gevonden: https://products.gecurrent.com/eu/led-signage-lighting</p> | <p>PL Polską wersję instrukcji instalacji oraz informacje dotyczące bezpieczeństwa można znaleźć w następującej lokalizacji: https://products.gecurrent.com/eu/led-signage-lighting</p> <p>PT A versão em Português das instruções de instalação e das informações de segurança pode ser encontrada na seguinte localização: https://products.gecurrent.com/eu/led-signage-lighting</p> <p>RO Versiunea în limba română a instrucțiunilor de instalare și a informațiilor de siguranță pot fi găsite la: https://products.gecurrent.com/eu/led-signage-lighting</p> <p>SV Ni hittar den svenska versionen av installationsanvisningarna och säkerhetsinformationen på följande plats: https://products.gecurrent.com/eu/led-signage-lighting</p> <p>SL Previdnostna opozorila in varnostne informacije so na zadnji strani vodnika za namestitve. Pred začetkom namestitve izdelka jih skrbno preberite: https://products.gecurrent.com/eu/led-signage-lighting</p> <p>SK Slovenskú verziu montážnej príručky a bezpečnostných instrukcií nájdete na nasledujúcej lokalite: https://products.gecurrent.com/eu/led-signage-lighting</p> |
|--|---|--|

For the latest North American install guides for your product go to: <https://products.gecurrent.com/led-signage-lighting>

For the latest European install guides for your product go to: <https://products.gecurrent.com/eu/led-signage-lighting>

Prepare Electrical Wiring **FOR UL ONLY**



Electrical Requirements

- Acceptable to use in dry, damp, and wet locations when installed correctly.
- The grounding and bonding of the LED Driver shall be done in accordance with National Electric Code (NEC) Article 600.
- Follow all National Electric Codes (NEC) and local codes.
- These products are only suitable for connection to a circuit from a Class 2 power source. These products have not been evaluated for use when connected to a power source that does not comply with Class 2 voltage and energy limited supplies.

Save These Instructions

Use only in the manner intended by the manufacturer. If you have any questions, contact the manufacturer.



RETROFIT SIGN CONVERSION LED KIT FOR USE ONLY IN ACCORDANCE WITH KIT INSTRUCTIONS. KIT IS COMPLETE ONLY WHEN ALL PARTS REQUIRED BY THE INSTRUCTIONS ARE PRESENT.

TROUSSE DE CONVERSION À DEL POUR LA MODERNISATION DES ENSEIGNES À UTILISER CONFORMÉMENT AU GUIDE D'INSTALLATION.

⚠ WARNING / AVERTISSEMENT

RISK OF ELECTRIC SHOCK

- Turn power off before inspection, installation or removal.
- Properly ground power supply enclosure.
- Not to be submerged or used in a marine environment.

RISK OF FIRE

- Use only suitably approved wire for input/output connections. Minimum size 18 AWG (0.82mm²)
- Follow all local codes.
- Waterproof wire connection for outdoor or wet installations. See instructions for details.
- Do not stretch light engines.
- Inspect and replace the light engines if any tear or damage affects their integrity.
- Avoid installation that leads to prolonged exposure to standing water or ice.

RISQUES DE DÉCHARGES ÉLECTRIQUES

- Coupez l'alimentation avant l'inspection, l'installation ou le déplacement.
- Assurez-vous de correctement mettre à terre l'alimentation électrique.
- Ne pas submerger ou installer dans un environnement marin

RISQUES D'INCENDIE

- N'utilisez que des fils approuvés par UL pour les entrées/sorties de connexion. Taille minimum 18 AWG (0.82mm²)
- Respectez tous les codes locaux.
- Étanchéfier les connexions électriques effectuées à l'extérieur ou pour un environnement exposé à l'eau. Voir les instructions d'installation pour plus de détails.
- Ne pas étirer les modules DEL Contour.
- Inspecter l'intégrité des modules DEL Contour et les remplacer s'ils sont déchirés ou endommagés.
- Éviter les installations avec une exposition prolongée à l'eau stagnante ou à la glace.

⚠ UL WARNING / AVERTISSEMENT UL

RISK OF FIRE OR ELECTRIC SHOCK

- LED Retrofit Kit installation requires knowledge of sign electrical systems. If not qualified, do not attempt installation. Contact a qualified electrician.
- Install this kit only in host signs that have been identified in the installation instructions and where the input rating of the retrofit kit does not exceed the input rating of the sign.
- Installation of this LED retrofit kit may involve drilling or punching of holes into the structure of the sign. Check for enclosed wiring and components to avoid damage to wiring and electrical parts.
- Do not make or alter any open holes in an enclosure of wiring or electrical components during kit installation.

RISQUE D'INCENDIE OU DE CHOC ÉLECTRIQUE

- L'installation de l'équipement de remplacement DEL exige la connaissance des systèmes électriques pour enseignes. Si non qualifié, ne tentez pas d'installation. Veuillez contacter un électricien qualifié.
- Risque d'incendie ou de choc électrique. Installez cet ensemble seulement dans des enseignes hôtes qui ont été identifiés dans les instructions d'installation et dont la capacité d'entrée de l'ensemble ne dépasse pas la capacité d'entrée de l'enseigne.
- L'installation de cet équipement de remplacement DEL peut impliquer le perçage ou le poinçonnage de trous dans la structure du panneau Vérifiez le câblage et les composants inclus pour éviter d'endommager le câblage et les composants électriques.
- Ne pas faire ou modifier les trous ouverts dans une enceinte de câblage ou de composants électriques pendant l'installation de cet équipement de remplacement DEL.

⚠ CAUTION / ATTENTION

RISK OF INJURY

- While performing installations described, gloves, safety glasses or goggles should be worn.

RISQUE DE BLESSURE

- Lors de l'exécution des installations décrites, des gants, des lunettes de sécurité ou des lunettes de protection doivent être portées.

This device complies with part 15 of the FCC Rules. Operation is subject to the following two conditions: (1) This device may not cause harmful interference, and (2) this device must accept any interference received, including interference that may cause undesired operation.

Note: This equipment has been tested and found to comply with the limits for a Class A digital device, pursuant to part 15 of the FCC Rules. These limits are designed to provide reasonable protection against harmful interference when the equipment is operated in a commercial environment. This equipment generates, uses, and can radiate radio frequency energy and, if not installed and used in accordance with the instruction manual, may cause harmful interference to radio communications. Operation of this equipment in a residential area is likely to cause harmful interference in which case the user will be required to correct the interference at his own expense.

This Class [A] RFLD complies with the Canadian standard ICES-005. Ce DEFR de la classe [A] est conforme à la NMB-005 du Canada.

Components and Tools Required

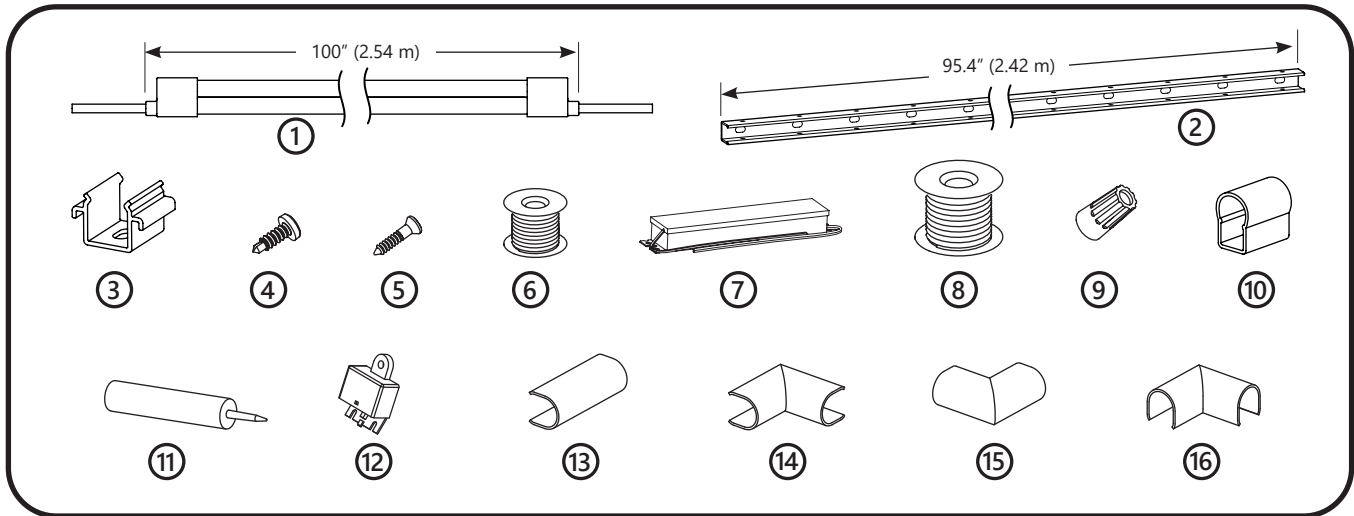

- ① Contour Gen 2 Flex Side Bend Light Engine
- ② GEXNFRL-1 Flex Rail or GEDSRLXX-3 Tetra SNAP Rail
- ③ GEXNFMC-1 Flex Mounting Clip
- ④ #6, #8 or #10 (M2, M3 or M4) self-drilling pan headed screws
- ⑤ #6 (M2) screws
- ⑥ Minimum 22 AWG (0.33mm²) tie-wire
- ⑦ 24 Volt power supply
- ⑧ UL approved 18 AWG (0.82mm²) supply wire
- ⑨ UL approved 22-14 AWG (0.33-2.08mm²) twist-on wire connectors
- ⑩ GEXNFEC-1 Flex End Cap
- ⑪ Electrical grade silicone.

Examples of electrical grade silicone:

- Momentive RTV 6702 (white) / RTV 6708 (clear) - Silicone Rubber Adhesive Sealant
- Momentive RTV 162 (White) - Silicone Rubber Adhesive Sealant-Electrical Grade
- Dow Corning 3140 (clear) - Non-Corrosive Flowable
- Dow Corning 3145 (clear or gray) - Non-Corrosive Non-flowable
- Dow Corning RTV 748 (white) - Non-Corrosive Sealant

Optional / Required for Wet Locations

- ⑫ Weather box GEXNWB2

Optional

- ⑬ Contour Light Guide connector
- ⑭ Contour Light Guide 90° inside corner
- ⑮ Contour Light Guide 90° outside corner
- ⑯ Contour Light Guide 90° planar corner

Cutting Resolution Table	
Light Engine Color	Cutting Resolution
Red, Red-Orange, Amber, Green, Blue, White	4 in. (101.6 mm)

METHOD A - Installing Light Engines With GEXNFRL-1 Flex Rail - Straight Runs Only

Planning First

Plan the layout by measuring the design layout and dividing by 8 ft. (2.44m) to determine the required quantity of Contour Gen 2 Flex. Refer to the **Cutting Resolution Table** on page 3 when cutting any Contour Gen 2 Flex section.

Do not use more than one suffix code for each respective application, as mixing suffix codes may result in appearance variation. Suffix code can be found on the packaging label.

NOTE: If mounting surfaces are rough or uneven, take the necessary precautions to avoid bending the rail when mounting.

If you have any questions about these instructions or your specific Contour application, please contact support at tetra.support@gecurrent.com

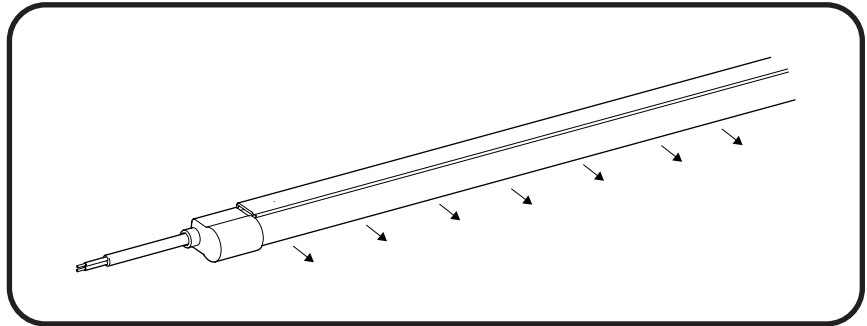

Installation

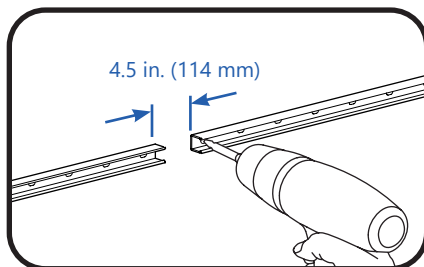

- 1 Mount the Flex rails so that they are gapped at least 4.5 in. (114 mm) apart if end to end, using a #6 or #8 (M2 or M3) screw at least every 2 ft. of rail but not less than 2 screws per rail.

NOTE: For an 8 ft. rail length, there will be 2.08 in. (52.8 mm) of excess light engine on each end.

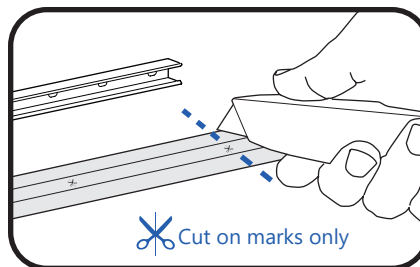

- 2 Using the Flex Rail final length, measure out the necessary length of Contour LED light engine so that it will extend at least 3/4 in. (19 mm). If required, use a sharp cutting tool to cut through light engine (refer to the **Cutting Resolution Table** on page 2).

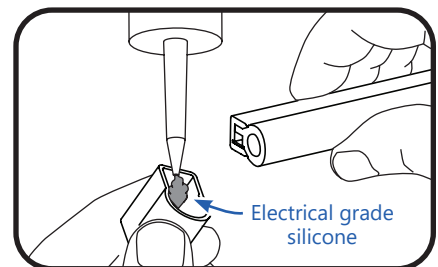

- 3 For cut end, fill cap with electrical grade silicone and push cap on the end to seal. Clean excess silicone.

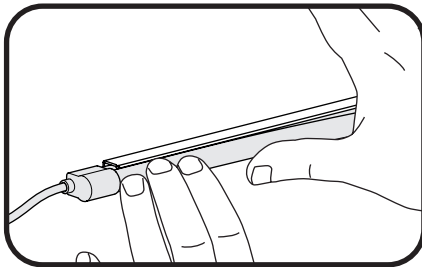

4 Push the light engine segments down into the Flex Rail.

⚠ WARNING/AVERTISSEMENT

RISK OF FIRE: The light engine is not intended for excessive or repetitive bending or stretching. If the silicone does crack, replace the light engine.

RISQUE D'INCENDIE: Les modules DEL Contour ne sont pas conçus pour des pliages excessifs, répétitifs ou pour être étirés. Si le silicone montre des signes de craquement, remplacer le module DEL Contour.

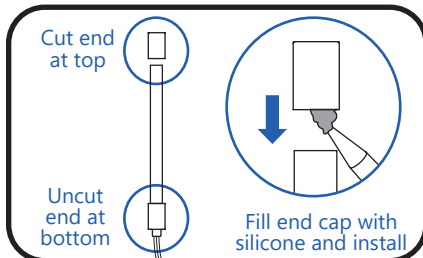

5 For vertical or near vertical installations, any cut-end termination of a Contour piece shall reside at the top of the design.

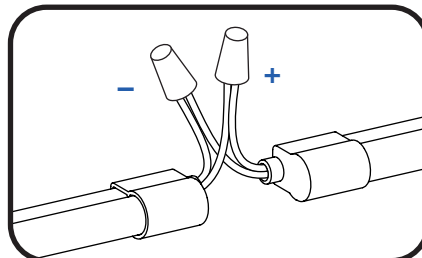

6 To connect two light engines, first strip wire ends back 0.5 in. (13mm). Then join wires together using twist-on wire connectors.

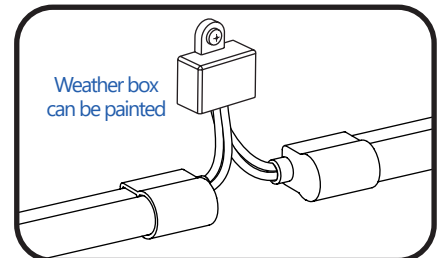

7 Insert wire connectors into weather box. Fill with electrical grade silicone and close box. Weather box can be mounted using #8 (M3) screws.

⚠ WARNING / AVERTISSEMENT

RISK OF FIRE: Waterproof wire connection and all cut ends for outdoor or wet installations. Weather box is required for all outdoor or wet locations electrical connections.

RISQUE D'INCENDIE: Étanchéfier les connexions électriques et sceller l'extrémité des sections coupées effectuées à l'extérieur ou pour un environnement exposé à l'eau. Un boîtier étanche est requis pour les connexions électriques effectuées à l'extérieur ou dans un environnement avec exposition à l'eau.

Joining with Light Guide Connectors, Corners and Bends

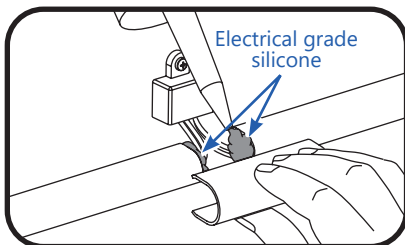

8 Linear: At each gap between sections, apply silicone on both sides to secure light guide connector. Snap on a light guide connector.

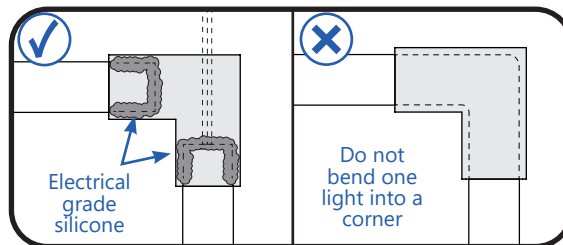

9 Corner: For all corners (planar, inside, outside) apply silicone on both sides to secure light guide corners. Snap on corner. Follow Steps 8-9 if wires are cut.

METHOD B - Installing Light Engines With GEXNPMC-1 Flex Mounting Clip

⚠ WARNING / AVERTISSEMENT

RISK OF FIRE: DO NOT bend the light engine to an inside radius that is tighter than 1 in. (25.4 mm).
RISQUE D'INCENDIE: Ne pas plier les modules DEL Contour avec un rayon de courbure inférieur à 1 pouce (25.4 mm).

Planning First

Plan the layout by measuring the design layout and dividing by 8 ft. (2.44 m) to determine the required quantity of Contour Gen 2 Flex. Refer to the **Cutting Resolution Table** on page 3 when cutting any Contour Gen 2 Flex section.

Do not use more than one suffix code for each respective application, as mixing suffix codes may result in appearance variation. Suffix code can be found on the packaging label.

DO NOT bend the light engine to an inside radius that is tighter than 1 in. (25.4 mm).

If you have questions about these instructions or your Contour application, contact support at tetra.support@gecurrent.com

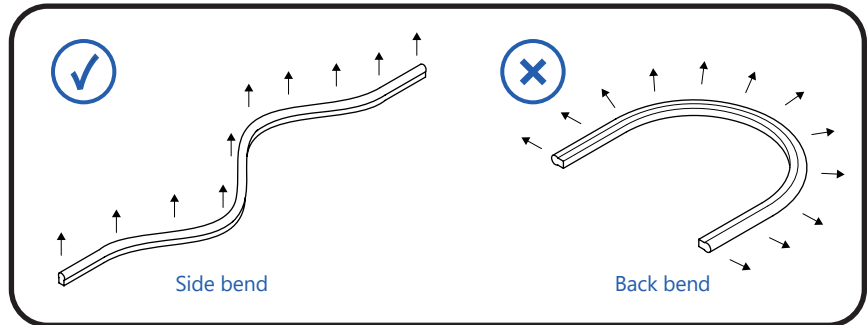

Installation

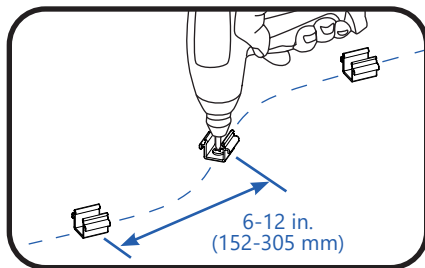

- 1 Install a Flex Mounting Clip, using #6 (M2) counter sink screws, every 6-12 inches (152-305 mm) on center until the end of the run is reached.

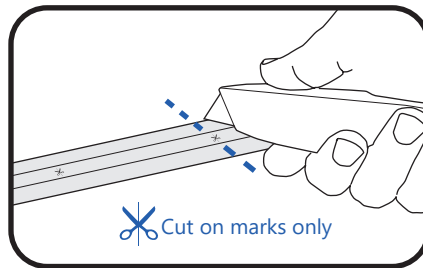

- 2 Using the light engine final length, measure out the necessary length of Contour light engine so that it will extend at least 3/4 in. (19 mm) past the last mounting clip. If required, use a sharp cutting tool to cut through light engine.

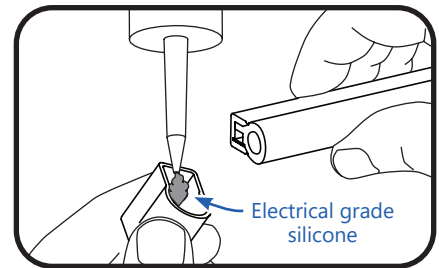

- 3 For cut end, fill cap with electrical grade silicone and push end cap on the end to seal. Clean excess silicone.

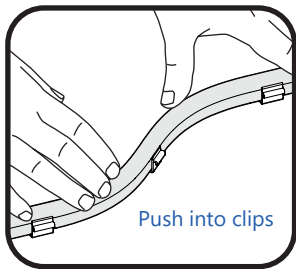

4 Push each light engine segment into the clips.

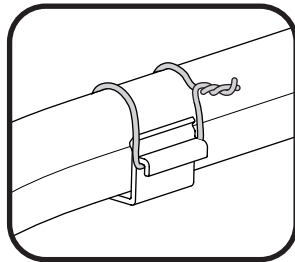

5 Secure light engine by twisting tie-wire around the mounting clip and light engine.

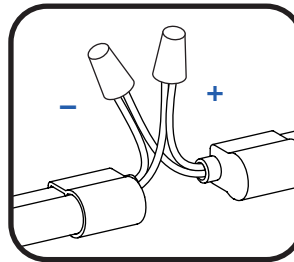

6 To connect two light engines, first strip wire ends back 0.5 in. (13mm). Then join wires together using twist-on wire connectors.

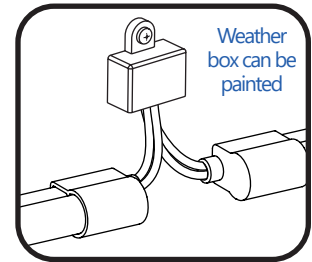

7 Insert wire connectors into weather box. Fill with electrical grade silicone and close box. Weather box can be mounted using #8 (M3) screws.

Connect Power Supply

⚠ WARNING/AVERTISSEMENT

RISK OF ELECTRICAL SHOCK: Turn power OFF before inspection, installation or removal.

RISQUES DE CHOC ÉLECTRIQUE: Coupez l'alimentation électrique avant d'inspecter, d'installer ou de déplacer le luminaire.

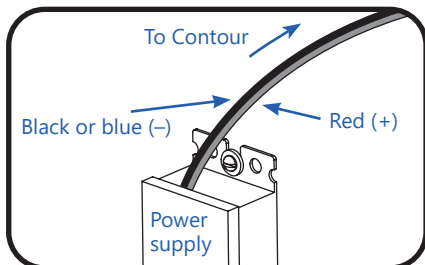

8 Run a wire from the power supply to a section of Contour. Power supply connection to the AC mains must be completed in an acceptable enclosure. Power supply loading is described on page 9.

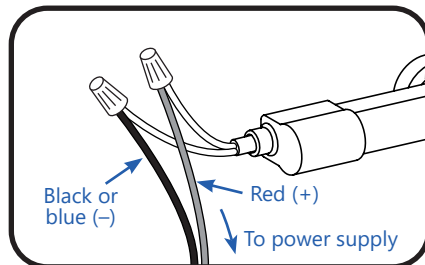

9 Strip wires back 0.5 in. (13mm). Connect the red wire (+) from the LED strip to the red wire (+) of the power supply. Connect the black wire (-) from the LED strip to the black or blue wire (-) of the power supply. Grounding and bonding must be done in accordance with National Electrical Code (Article 600). See power supply instructions.

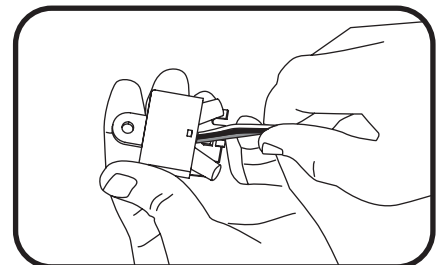

10 Insert wire connectors into weather box. Fill with electrical grade silicone and close box.

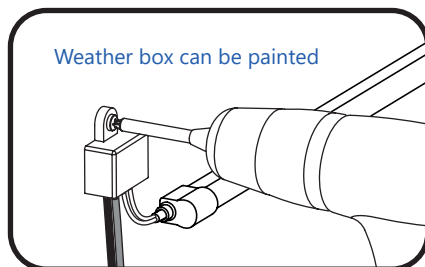

11 Secure the weather box using a #6 or #8 (M2 or M3) screw.

Retrofit Instructions

1. **(Existing Signs Only)** Prior to installation, survey the site for information regarding power and accessibility inside and outside the building. Ensure that the branch circuit supplying the existing transformer or ballast will be within the voltage ratings of the new LED power supply, and have a current rating not exceeding 20A, or that permitted by applicable local, state, or country electrical codes (whichever is less).
2. **(Existing Signs Only)** Remove the existing lighting equipment to be replaced, such as neon tubing or fluorescent tubes; and associated transformers and ballasts. Care should be taken not to break the existing neon or fluorescent tubes. **NOTE:** Follow all federal and local regulations when disposing of neon tubing, fluorescent tubes, transformers and ballasts.
3. **(Existing Signs Only)** If removal of the existing lighting equipment eliminates the disconnect switch, as required by applicable local, state, or country electrical codes; a new disconnect switch must be installed.
4. **(Existing Signs Only)** Repair and seal any unused openings in the electrical enclosure. Openings greater than 12.7-mm (1/2-in) diameter require a metal patch secured by screws or rivets and caulked with non-hardening caulk. Smaller openings may be sealed with non-hardening caulk.
5. Using the layout guidelines above, determine required number of LED modules required to illuminate the sign.
6. A 24VDC Class 2 Power Supply, as listed below, must be used with this retrofit kit. Determine the number of Power Supplies required to power the number of LED modules required to illuminate the sign, so as not to overload the Power Supply chosen.
7. Follow Method A, B or C to mount the Contour Gen 2 Flex.
8. Connect the DC output of the power supply to the LED modules using the Electrical Connections instructions above.
9. Connect the power unit to the supply in accordance with the applicable local, state, and country electrical codes, and the instructions found in the power supply installation guide.
10. If required, the disconnect switch shall be installed by qualified personnel, in accordance with applicable local, state, and country electrical codes.

Troubleshooting

Symptom	Condition	Solution
All LEDs are OFF	No AC input.	Attach AC input and/or check circuit breaker.
	Incorrect wire attachment.	Check wire connection(s) at the Contour Gen 2 Flex LED light engine and power supply for improper connections or short circuits. Make sure you have positive to positive and negative to negative wire connections.
Some LEDs appear dim	Overload (maximum load exceeded).	Ensure the overall length of Contour LED Gen 2 Flex light engine does not exceed the maximum load as detailed in the Tetra Power Supply Installation Instructions .
	Maximum recommended supply wire length exceeded.	Reduce the length of supply wire equal to or below the recommended maximum.
	Mixed Suffix Codes of LED light engine within an application.	Make sure that all LED light engines have the same Suffix Code (Suffix Code is located on each packaging label).
Some of the sections are not illuminated	Incorrect wire attachment.	Check the wire connections at the Contour Gen 2 Flex LED light engine for improper connections. Make sure you have positive to positive and negative to negative wire connections. Check for improper cutting resolution locations (see table on Page 2).
Light/dark banding along a section	LED light engine flexed in the wrong direction or smaller than the minimum bend radius during installation.	Remove LED light engine and properly install. Inspect and replace light engine if damaged.

Maximum Loading per 24 VDC Class 2 Power Supply

Power Supply	GEXNFS32-1, GEXNFS65-1, GEXNFSRD-1, GEXNFSGL-1, GEXNFSBL-1, GEXNFSYG-1, GEXNFSRC-1
Rating per module	24VDC, 1.4W/ft. (Strip)
GEPS24-25U-NA, GEPS24-25-EU (CE only) <i>Load shall not exceed 0.83A</i>	15ft. (4.57 m)
GEPS24D-60U-GLX, *GELP24-60U-GL <i>Load shall not exceed 2.5A</i>	39 ft. (11.88 m)
GEPS24D-80U <i>Load shall not exceed 3.3A</i>	49ft. (14.93 m)
GEPS24-100U-GLX, GEPS24D-100U-NA, USVI-100024FE, USVI-100024FBA <i>Load shall not exceed 4.0A</i>	59ft. (17.98 m)
GEPS24-100U-GLX2, GEPS24-100U-TT <i>Load shall not exceed 4.0A</i>	62ft. (18.89 m)
GEPS24-200U-GLX2 <i>Load shall not exceed 4.0A per each (of 2) output channels</i>	62ft. (18.89 m) per bank 124 ft. (37.78 m) per PS
GEPS24-300U-GLX2 <i>Load shall not exceed 4.0A per each (of 3) output channels</i>	62ft. (18.89 m) per bank 186 ft. (56.67 m) per PS

NOTE: For linear long runs, center connection to the LED strip is recommended to minimize voltage drop.

*GELP24-60U-GL minimum load = 15 ft. (4.57 m).

Maximum Remote Mounting Distance from Driver Output

Power Supply Wattage	18 AWG/0.82 mm ² Supply Wire	16 AWG/1.31 mm ² Supply Wire	14 AWG/2.08 mm ² Supply Wire	12 AWG/3.31 mm ² Supply Wire
25W	20 ft./6.1 m	–	–	–
60W, 80W, 100W, 180W, 200W, 300W	20 ft./6.1 m	25 ft./7.6 m	35 ft./10.6 m	40 ft./12.1 m

Dismantling

At the end of life, the contained LED light source may be cut out using suitable wire cutters, removed from the mounting surface, then replaced per the cutting and installation instructions above, or dismantled and taken to a communal collecting point for environmentally friendly disposal in accordance with local regulations by a professional installer.

This product is intended solely for the use of non-residential signage lighting and is not intended for use in any other applications.
Conforms to the following standards:



Electrical products must not be thrown out with domestic waste. They must be taken to a communal collecting point for environmentally friendly disposal in accordance with local regulations. Contact your local authorities or stockist for advice on recycling. The packaging material is recyclable. Dispose of the packaging in an environmentally friendly manner and make it available for the recyclable material collection-service.