





### FURNITURE TIPPING RESTRAINT INSTRUCTIONS

Young children may be injured by tipping furniture and the use of a tipping restraint is highly recommended.

When properly installed, this restraint could provide protection against the unexpected tipping of furniture due to small tremors, bumps or climbing. We recommend mounting this restraint to a wall stud.

**WARNING:** This product is only a deterrent. It is not a substitute for proper adult supervision.

### HARDWARE LIST

NO	DESCRIPTION	QTY
1	 PLASTIC BRACKET	2
2	 RESTRAINT STRAP	2
3	 PHILLIPS SCREWS (M4 x 30)	4
4	 PLASTIC ANCHOR	4

### INSTALLATION INSTRUCTION

1. Mark locations of the plastic brackets on the wall approximately 6" below the top-back corner of the furniture.
2. Drill a shorter hole into the wall stud. If wall stud is not available, drill a hole into the wall and insert plastic anchor. Gently tap the anchor until the flange is flush with the wall.
3. Attach the plastic brackets by inserting screw through the bracket and into the wall. Place the furniture so that the back posts are in line with the brackets on the wall.
4. Lace one end of the nylon restraint strap go through the bracket and the back post. Bring both ends together and slide the beaded end until it snaps/ locks into the keyhole slot.
5. To double lock; return the beaded end back through the keyholes as shown.
6. Check to make sure the straps are securely laced and locked to the brackets.

### CARE INSTRUCTIONS:

- Dust often using a clean, soft, dry lint-free cloth.
- Blot spills immediately and wipe with a clean, damp, cloth.
- We do not recommend the use of chemical cleansers, abrasives, or furniture polish on our lacquered finish.

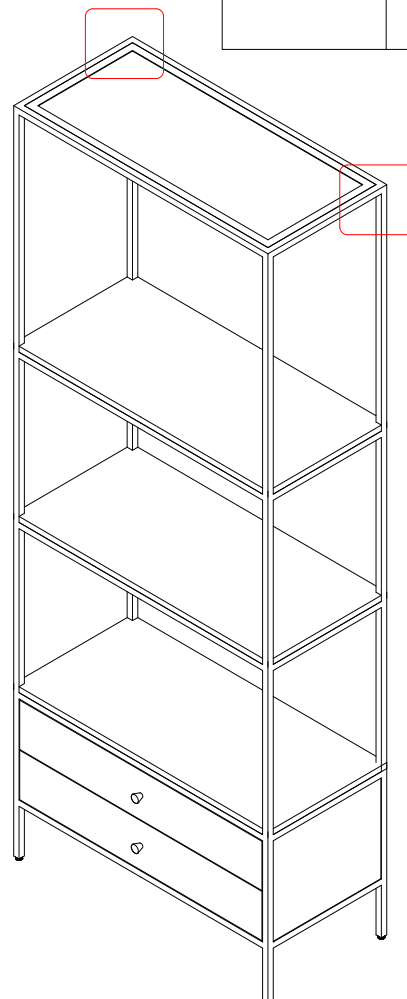
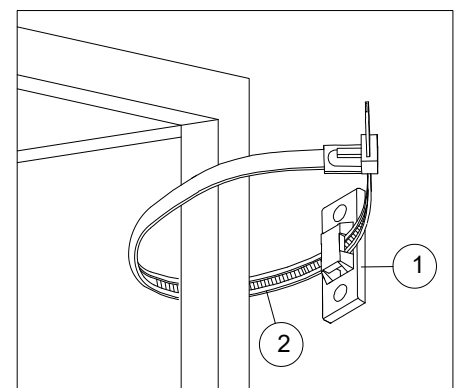
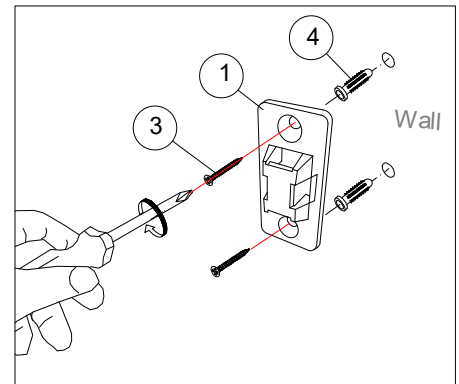

*Thank you for your purchase*  
www.resourcedecor.com