

CUSTOMER NAME	
PROJECT NAME	
DATE	TYPE
CATALOG NUMBER	

## Arize Factor® ML900

HORT146EU

### High power for high-density cultivators

Industry-leading performance, efficiency, and versatility means the Arize Factor ML900 can easily adapt to your grow style and help you to exceed your productivity goals. This rugged and scalable solution has been engineered specifically for the needs of the most demanding, high-density, indoor cannabis cultivators.

### Optical System

Typical Photon Flux	1,404 - 1,741 $\mu\text{mol/s}$
Light Distribution	140°
Spectrums	PKR, PKB, PKF, BRI and BRV

### Ambient Temperature

TYPE	TEMPERATURE RATING
Operating Temperature	0°C to 30°C (32°F to 86°F)

### Electrical

Dimming Range	0-10V
Max Source Current	450uA
Efficacy Range	2.3 to 2.8 $\mu\text{mol/j}$
Dim-to-Off <sup>3</sup>	Yes
Dim Off Voltage	0.35-0.65V (typ. 0.5V)
Dim On Voltage	0.55-0.85V (typ. 0.7V)
Dimming Output Range	10%-100%
Power Factor	>0.9
Absolute Maximum Dimming Voltage	20V
Max. Remote Mount Distance	6 ft (1.83 m)
Cooling	Passive
IP Rating	IP65

For input voltage option 3, dimming control input is non-isolated from Class 1 driver output circuit. Use with sink dimmers only

<sup>3</sup> Refer to installation guide for dimming functionality details

<sup>4</sup> Tested at 30°C per TM-21

### Rated Lifetime

L90: >50,000 hours<sup>4</sup>

### Certifications & Warranty

Five-year system warranty  
cULus E492907, CE, UKCA



CUSTOMER NAME	
PROJECT NAME	
DATE	TYPE
CATALOG NUMBER	

### Ordering Information

#### GEHF

MODEL	MODEL	MOUNTING	SPECTRUM	INPUT VOLTAGE	DISTRIBUTION	OPTIONS	GEN	PACKAGING
GEHF	H2 2x high output bars, 1x 600W driver	S Suspended	PKR	7 220-240V	W Wide Batwing	X Leader Cable, Open Lead	1	[Blank] Single Pack
		U 1 5/8" Unistrut	PKB	8 380-415V				M1 Bulk Pack
		X Suspended + PS Wire-form <sup>1</sup>	PKF	N No PS				N No Leader Cable
			BRI					
			BRV					

#### SPECTRUM TABLE

SPECTRUM	TYPICAL PHOTON FLUX <sup>1</sup> (μMOL/S)	POWER <sup>2</sup> (W)	EFFICACY <sup>2</sup> (μMOL/J)	DC INPUT VOLTAGE	LIGHT BAR MODEL NUMBER <sup>3</sup>
PKR	1,741	639	2.7	143	GEHF-HPKRW1
PKB	1,695	626	2.7	141	GEHF-HPKBW1
PKF	1,729	626	2.8	141	GEHF-HPKFW1
BRI	1,448	638	2.3	143	GEHF-HBRIW1
BRV	1,404	632	2.3	142	GEHF-HBRVW1

<sup>1</sup> Typical PPF +/-10% <sup>2</sup> Tested at maximum input voltage of 480VAC <sup>3</sup> See Order Code Table on page 4 for ordering logic

#### ACCESSORIES

ORDER CODE	SKU	DESCRIPTION	BOX QUANTITY
GECA30C18-BA03B	93118693	914 mm Interconnection Cable, CE	60
GECA30B18-BA06B	93067609	152 mm Interconnection Cable, CE	32
GECA30B18-BA12B	93067610	304 mm Interconnection Cable, CE	16
GEHR-BRA WIREFORM	93153914	Factor Suspended Mount Wireform Bracket	1
GEHR-BRA WIREFORM 1X5/8	95052672	Factor Suspended Mount Wireform Bracket 4.13cm	1
GEMB-BAW1	93153918	Factor Rolling Rack Mount, 60.96 cm	1
GEMB-BAW2	93153917	Factor Rolling Rack Mount, 121.92 cm	1
GEHAK-NN-NE-NO	95047411	304 mm Power Supply Remote Mounting Kit	1
GEHR-HAR M15 SHORTING CAP	93306044	Replacement Shorting Cap	1

#### DISCLAIMER

Horticultural lighting only. Not suitable for general lighting applications

Electrical products must not be thrown out with domestic waste. They must be taken to a communal collecting point for environmentally friendly disposal in accordance with local regulations. Contact your local authorities or stockist for advice on recycling. The packaging material is recyclable. Dispose of the packaging in an environmentally friendly manner and make it available for the recyclable material collection service.



### Product Dimensions

DIMENSIONS AND WEIGHT					
	LENGTH	WIDTH	HEIGHT	WEIGHT	
Fixture	46.97" 1193 mm	3.58" 91 mm	2.08" 53 mm	5.7 lbs 2.6 kg	
Power Supply <sup>1</sup>	10.81" 274.5 mm	9.96" 252.9 mm	3.65" 92.8 mm	7.7 lbs 3.5 kg	
Power Supply <sup>2</sup>	12.60" 320 mm	5.94" 151 mm	1.81" 46 mm	7.1 lbs 3 kg	

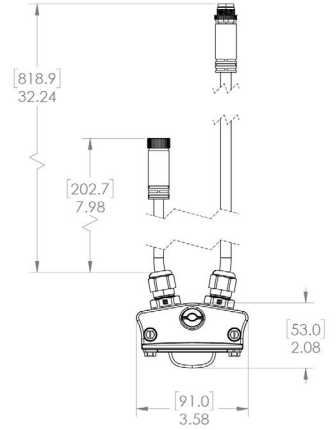

<sup>1</sup> 220-240V input voltage    <sup>2</sup> 380-415V input voltage

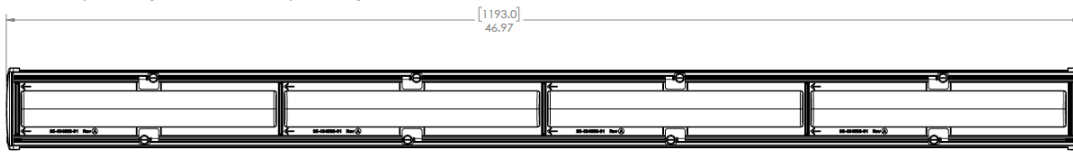

### Photometric Data

#### Type R

High red light to optimize plant growth and photosynthesis

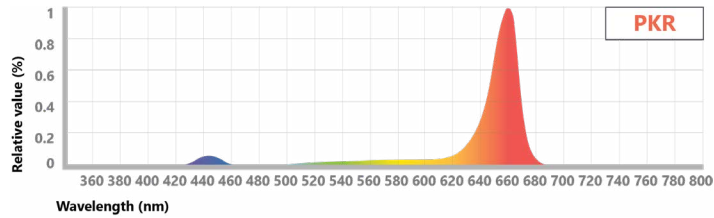

#### Type B

Light that supports biomass and secondary metabolite production

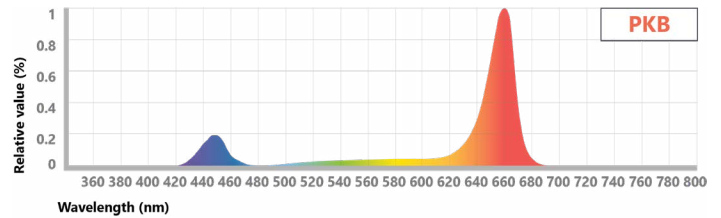

#### Type F

Encourages an expansion response for more robust growth

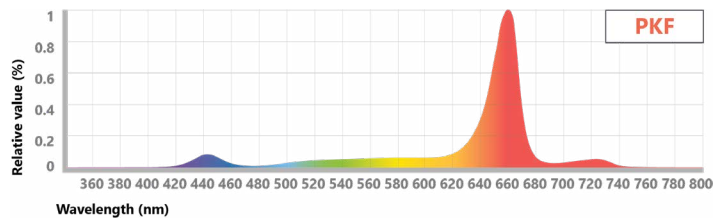

#### Type BR

Increased blue ratio boosts secondary metabolite production to promote crop quality and phytochemical profile

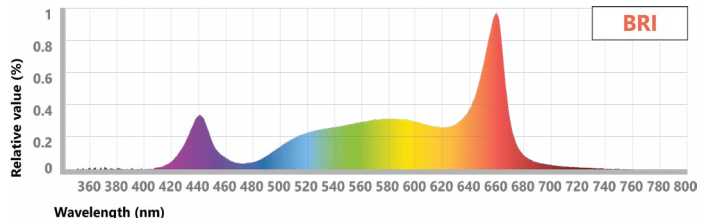

SPECTRUM PHOTON DISTRIBUTION				
Ratio	Blue PF	Green PF	Red PF	Far Red PF
PKR	8%	15%	77%	0%
PKB	16%	15%	69%	0%
PKF	8%	15%	72%	5%
BRI	15%	38%	47%	0%
BRV	25%	38%	37%	0%

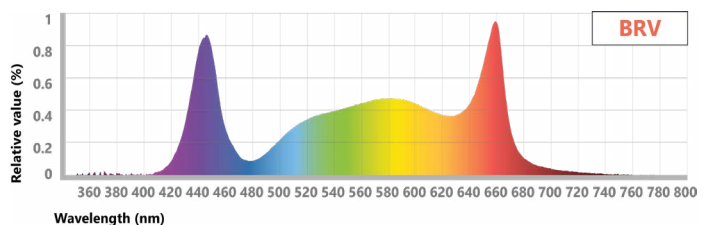

CUSTOMER NAME	
PROJECT NAME	
DATE	TYPE
CATALOG NUMBER	

## Why Factor?

### 1. Rolling Rack Mount

Factor adapts to your grow, not the other way around. The system can be installed on the side of a grow cart using the transversal bar, allowing it to fit below ventilation systems.

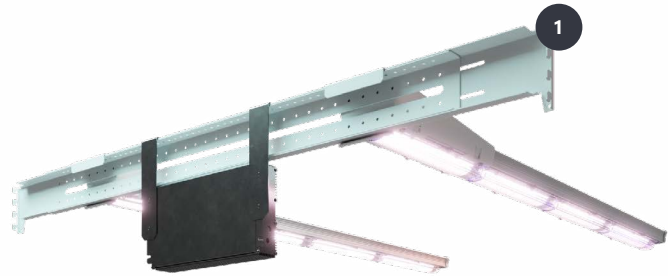

### 2. Suspended Mount

One size fits all. Straightforward hooks allow the light bars to be hung from any rack, and the power supply can be remotely mounted, meaning the Factor can be used in any setup.

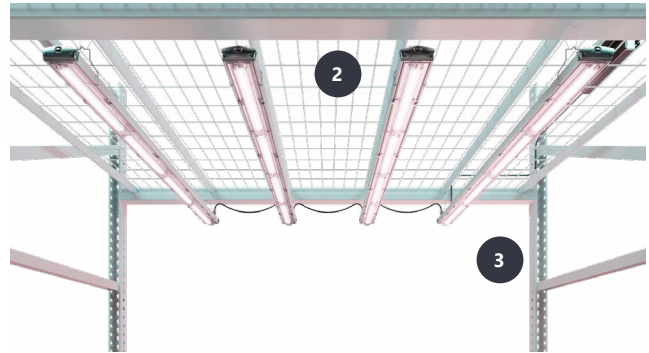

### 3. Reliability

We perform the most extensive, stringent testing in the industry. We test the LED, water and dust ingress protection, sub-system and complete system at our in-house and independent laboratories around the world. Validation of our designs, components, products and processes include high temperature, high humidity and accelerated life testing.

### 4. Do More With Less

Compared to multi-bar arrays, the Factor maintains or exceeds PPF levels over a 4' x 4' area using only two bars per array, lowering capital and operating expenses

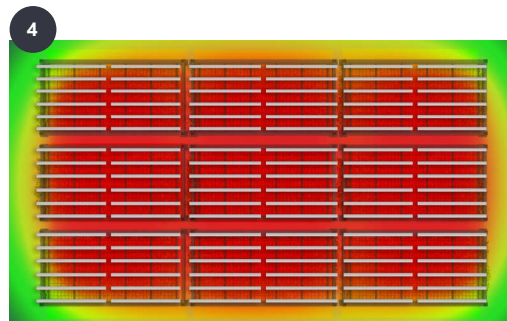

Multi-bar arrays

