

Lumination® LMM Series

LED Track Light Recessed Multiples
2x2 Head Trim



CUSTOMER NAME _____

Project Name _____

Date _____ Type _____

Catalog Number _____

The Lumination® LMM Series - 2x2 Head LED Luminaire is a match in a recessed multiple format to the LTM Track Light with the same high performance and depth of product offering. The Lumination® LMM LED platform offers long life and high efficiency to minimize operating and maintenance costs.

CONSTRUCTION

Housing: Die-cast and precision machined head
Lens: Custom designed spot optical system optimizes CBCP
Paint: Textured powder coat finish
Weight: 13 lbs. (5.9kg.)
Optical Assembly: Silicone optic with high thermal resistance prevents yellowing

OPTICAL SYSTEM

Lumens: Up to 5280 lumens
Distribution: Spot (15°), Narrow Flood (18°), Flood (25°)
Wattage: Up to 71 watts
Efficacy: Up to 88 LPW
CCT: 2700K, 3000K, 3500K, 4000K
CRI: 80 CRI, 90 CRI

ELECTRICAL

Input Voltage: 120-277V
Input Frequency: 50/60 Hz
Standard Dimming Control: 0-10V, Dimming
Power Factor (PF)*: > 0.9%
Total Harmonic Distortion (THD)*: < 20%

* PF and THD may vary with options

CONTROLS

Dimming: 0-10V, Dimming

LUMEN AMBIENT TEMPERATURE

TYPE	TEMPERATURE RATE
OPERATING TEMPERATURE	-20C to +30C (-4F to +86F)

LUMEN MAINTENANCE

LXX(10K) @ Hours 50,000 HR
L85

MOUNTING

- Standalone rough-in kit for installation in finished and t-grid ceilings

DESIGN LIFE & WARRANTY

- UL Listed and Energy Star rated
- Current's Limited 5-year Warranty:
Please refer to document **IND599** for more information.



Lumination® LMM Series

LED Track Light Recessed Multiples
2x2 Head Trim

Ordering Information

CUSTOMER NAME

Project Name _____

Date _____ Type _____

Catalog Number _____

Ordering Information (Important: Must order LMM Fixture + LMM Rough-in Kit, Both parts required for complete installation.):

LMM **Q** **A** **0** **V** **Q** **TR** **D**

FAMILY	FIXTURE TYPE	GENERATION	VOLTAGE	NOMINAL LUMENS	DISTRIBUTION	CRI	CCT	DIMMING	CONTROLS	MOUNTING	FINISH	DIFFUSER	OPTIONS
LMM= Lumination Recessed Mini Multiples	QR= Semi- Recessed 2x2 Head QS= Recessed 2x2 Head	A= 1 st Generation	0= 120- 277V	09= 950 lm 11= 1150 lm 13= 1375 lm	SP= Spot (15°) NF= Narrow Flood (18°) FL= Flood (25°)	8= 80 9= 90	27= 2700K 30= 3000K 35= 3500K 40= 4000K	V= 0-10V Dimming	Q= None	TR= Trim	WHITE= White BLCK= Black SLVR= Silver	DXX= None D03= 3.5°Diffuser D05= 5°Diffuser D07= 7.5°Diffuser D10= 10°Diffuser D20= 20°Diffuser DL6= 60°x10° Diffuser DL3= 30°x3° Diffuser	(blank)= None HX= Hexcel SN= Snoot HS= Snoot + Hexcel

Claims - based on 3000K

CONFIGURATION	FIXTURE LUMENS	FIXTURE WATTS	FIXTURE LPW	LUMENS PER HEAD
4-Head, Standard White 09	3800	43	88	950
4-Head, Standard White 11	4600	55	83	1150
4-Head, Standard White 13	5280	71	74	1320

LMM Rough-In Kit

MATERIAL	MATERIAL DESCRIPTION	PRODUCT DESCRIPTION
93039500	LMMRQA1	LMM Rough-In Kit, 2x2 Head, 120V
93039505	LMMRQA4	LMM Rough-In Kit, 2x2 Head, 277V

Field-installable Optical Accessories

MATERIAL	MATERIAL DESCRIPTION	PRODUCT DESCRIPTION
93026378	LT MDF035	LTM 3.5° Diffuser
93026529	LT MDF05	LTM 5° Diffuser
93026530	LT MDF075	LTM 7.5° Diffuser
93026901	LT MDF10	LTM 10° Diffuser
93026902	LT MDF20	LTM 20° Diffuser
93026903	LT MDF30	LTM 30° Diffuser
93026904	LT MDF6010	LTM 60°x10° Linear Spreader
93026905	LT MDF303	LTM 30°x3° Linear Spreader
93026697	LTMSNWHITE	LTM White Snoot
93026906	LTMSNBLCK	LTM Black Snoot
95019410	LTMSNSLVR	LTM Silver Snoot
93026696	LTMHX	LTM Hexcel Louver

Lumination® LMM Series

LED Track Light Recessed Multiples
2x2 Head Trim

Photometric Data

CUSTOMER NAME

Project Name _____

Date _____ Type _____

Catalog Number _____

STANDARD LED CONVERSION TABLE

Lumen and CBCP output varies based on Wattage, CCT and CRI. Table below is based on 3000K, 80 CRI fixture. To estimate lumen and CBCP output of other combinations, multiply photometric data by factors below.

827	830	835	840	927	930	935	940
0.95	1	1.03	1.05	0.8	0.83	0.85	0.87

PHOTOMETRIC DATA

20 Watt -1320 Lumens per head
Spot Flood Distribution -15°Beam

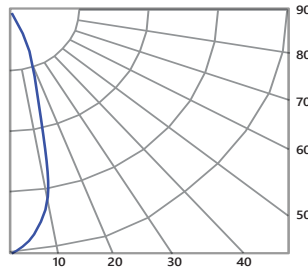

CANDLEPOWER SUMMARY	
Angle	Candela
0	12243
5	9730
15	1059
25	102
35	62
45	26
55	15

CONE OF LIGHT		
Height	fc	Dia. (ft)
6	340	1.7
8	191	2.3
10	123	2.9
12	85	3.5
14	62	4.1
16	48	4.6

20 Watt -1320 Lumens per head
Narrow Flood Distribution -18°Beam

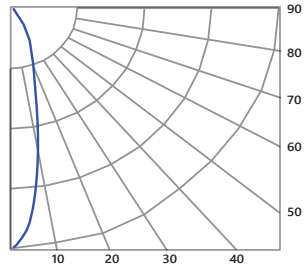

CANDLEPOWER SUMMARY	
Angle	Candela
0	8919
5	7045
15	1478
25	188
35	77
45	39
55	21

CONE OF LIGHT		
Height	fc	Dia. (ft)
6	248	2.0
8	139	2.7
10	89	3.4
12	62	4.0
14	45	4.7
16	35	5.4

20 Watt -1320 Lumens per head
Flood Distribution -25°Beam

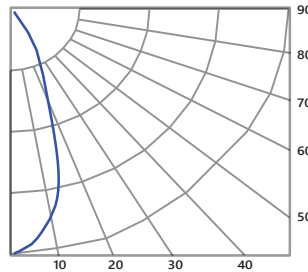

CANDLEPOWER SUMMARY	
Angle	Candela
0	4893
5	4638
15	2291
25	439
35	135
45	60
55	30

CONE OF LIGHT		
Height	fc	Dia. (ft)
6	136	2.8
8	77	3.8
10	49	4.7
12	34	5.7
14	25	6.6
16	19	7.6

Lumination® LMM Series

LED Track Light Recessed Multiples
2x2 Head Trim

Dimensions

CUSTOMER NAME

Project Name _____

Date _____ Type _____

Catalog Number _____

SEMI-RECESSED

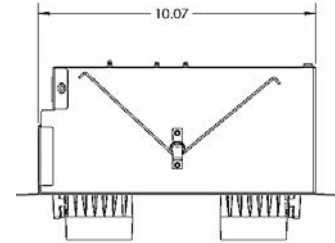
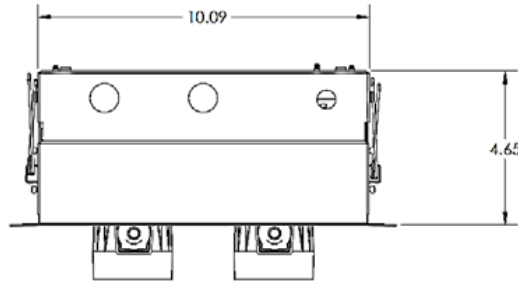
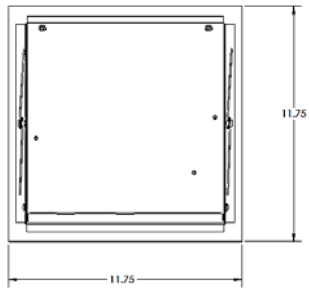

FULLY-RECESSED

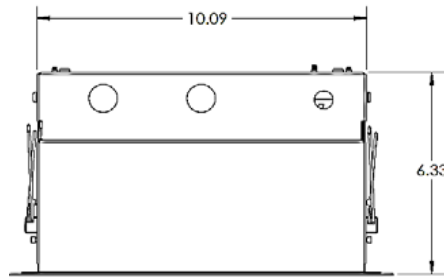
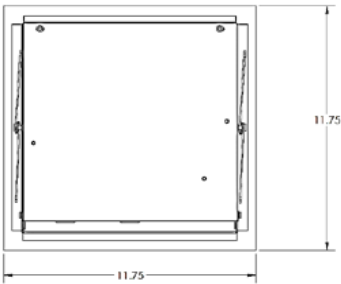

Width is same for both Semi-Recessed and Fully-Recessed

ROUGH IN KIT INFORMATION

MATERIAL	MATERIAL DESCRIPTION	PRODUCT DESCRIPTION
93039500	LMMRKQA1	LMM Rough-In Kit, 2x2 Head, 120V
93039505	LMMRKQA4	LMM Rough-In Kit, 2x2 Head, 277V

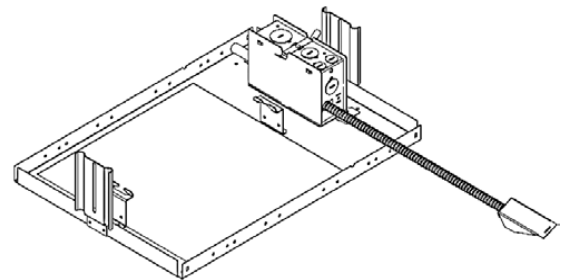
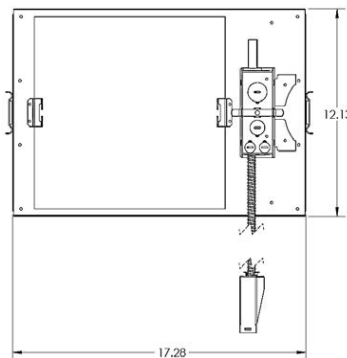

For Product or Technical Questions:

Email: lightingprodinfo@gecurrent.com

Phone: +1 888 694 3533, option 2