





IMPORTANT SAFETY INSTRUCTIONS

1. Adult assembly only owing to the presence of small parts, sharp points and edges.
2. Professional installation is recommended. Serious injury or death can occur if mirror is not hung correctly. Do not use wire to hang the mirror. Please follow correct hanging methods for your wall type. Your safety is dependent on the construction and strength of the wall to which it is attached.
3. Check mirror periodically to see that no fittings have loosened and need attention.

NO.	ITEM	DESCRIPTION	QTY.
1		Wall Bracket	1 pc.
2		Hollow Wall Anchor	7 pcs.
3		Plastic Anchor (47mm L)	7 pcs.
4		Screw M4 x 40mm	7 pcs.

CARE INSTRUCTIONS

1. Clean periodically by wiping the frame and glass panels with damp cloth or mild detergent. Do not use abrasive cleaners.

ASSEMBLY INSTRUCTIONS BY WALL TYPE

- **CONCRETE:** drill pilot hole on each marking and then insert plastic anchor. Use a screwdriver to attach the bracket to the wall with screws.
- **DRYWALL WITH STUDS:** use screws to affix to studs, and use hollow wall anchors and screws to affix to drywall .
- **DRYWALL WITHOUT STUDS:** use hollow wall anchors and screws to affix to drywall.

CONCRETE

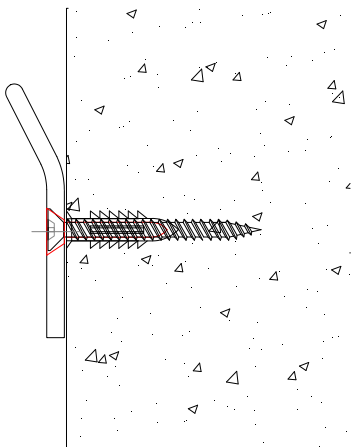

DRY WALL W/ STUDS

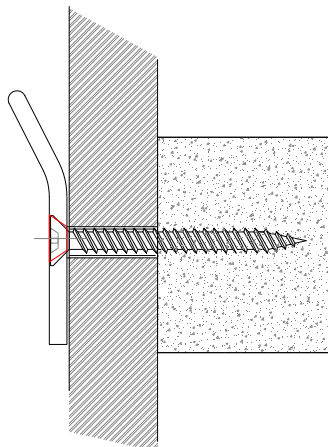

DRY WALL W/O STUDS

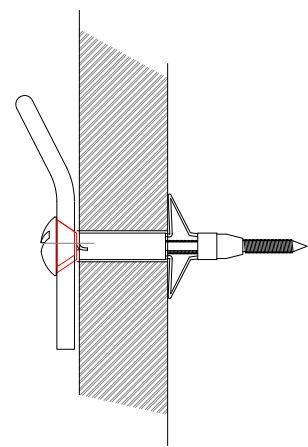

ASSEMBLY INSTRUCTIONS

1. Pre-set the mirror on your desired location and mark the location with a light pencil mark. Use tape or pencil to transcribe the location of the back of the mirror's pre-installed bracket to the wall. Below this marking is where you will install the included metal wall-mount bracket part (1). See FIGURE 02.
2. Hold the bracket (1) against the wall and mark with pencil the locations of the bracket screw holes, ensuring levelness. See FIGURE 01.
3. Drill a hole on each mark's and then tap anchor into hole until flush with surface. See page 1 for mounting instructions based on your wall type, concrete, drywall, or drywall and studs.
4. Tighten the screws into the anchors while maintaining constant pressure on the anchor to set. Remove screws. Hold metal bracket over the inserted anchors and reinstall screws through the wall bracket holes and tighten until snug against wall. See FIGURE 01.
5. Install the mirror on the wall bracket as illustrated on FIGURE 02.

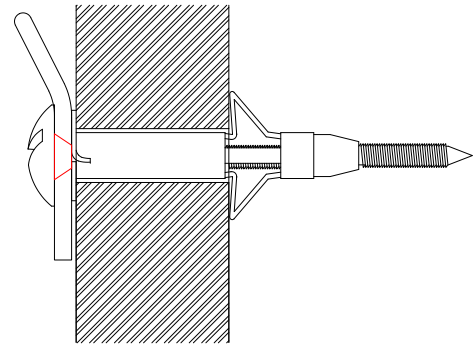

FIGURE 01

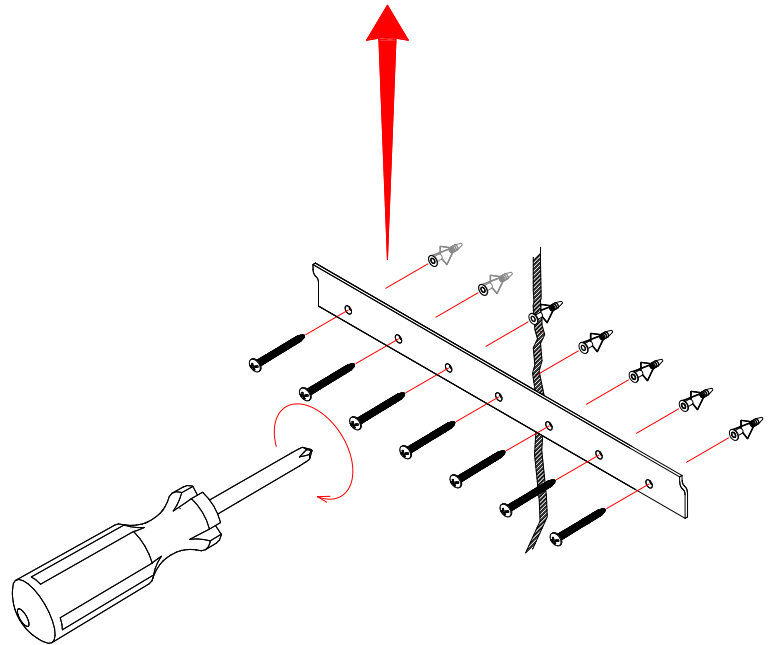

FIGURE 02

