

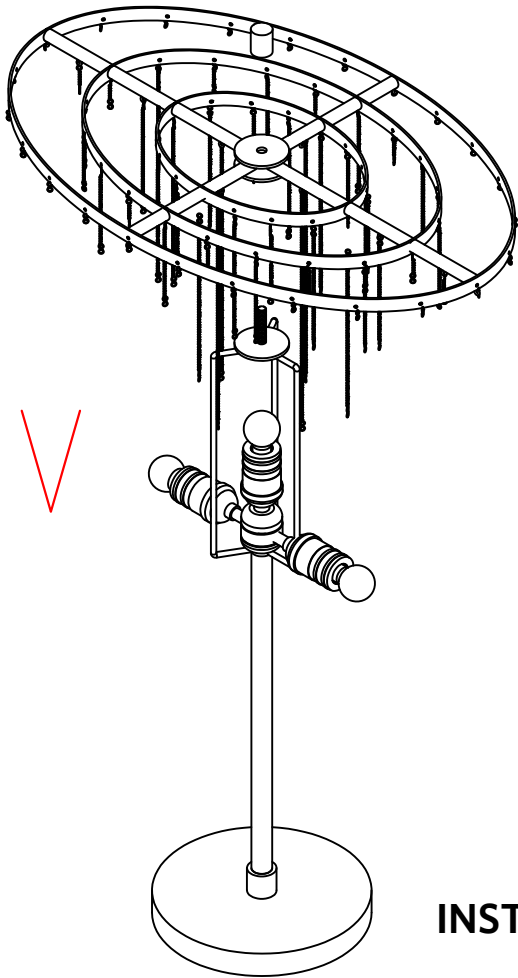



# THE CLOUD TABLE LAMP

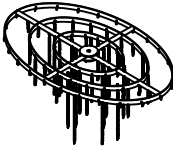

A		FINIAL	
B		LAMP BASE	
C		TOP DECO	
D		MEDIUM GLASS DECO (Dia.150mm)	18 PCS
E		SMALL GLASS DECO (Dia.120mm)	46 PCS

## INSTRUCTIONS

1. Place the base on a flat working surface.
2. Align and insert the Top deco spider ring into the threaded nipple of the harp and secure these with the finial.
3. Install Type A Medium base bulb into the lamp-holder.

## CARE INSTRUCTIONS:

Avoid the use of all polishers, cleaners, and abrasives, as they will damage the finish of your lamp. To remove dust or fingerprints, wipe gently with a soft, clean cloth.

FIGURE 1

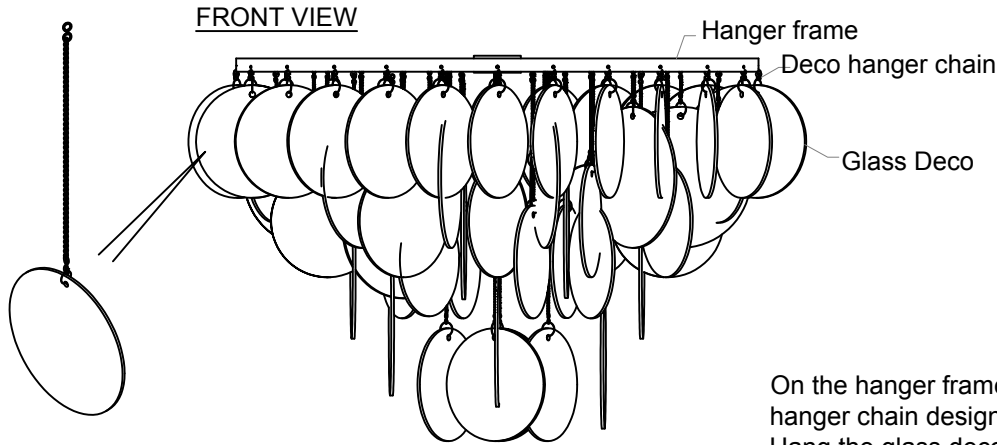

On the hanger frames have the pre-attached deco hanger chain designed for the glass deco hanging. Hang the glass deco on each hanger chain, as per illustrated in FIGURE 1.

**NOTE:** There are 2 sizes of glass deco. Make sure each piece will be hook on correct position. Refer FIGURE 2

FIGURE 2

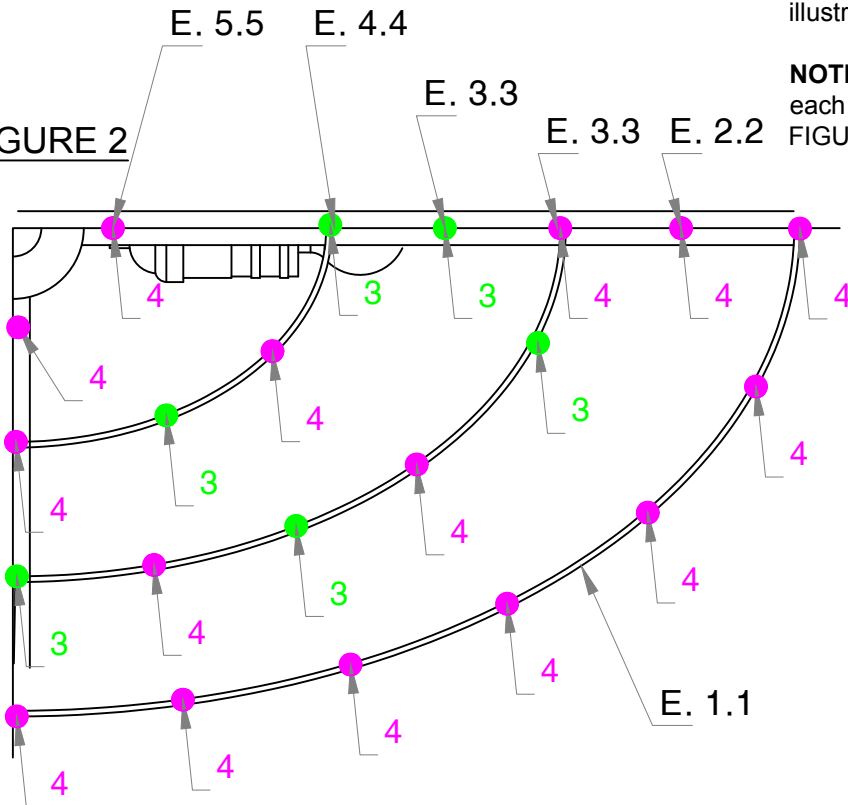

E. 1.1: + All glass (4): 24pcs have no chain only hook

E. 2.2: + All glass (4): 2pcs have the same length of chain: 30mm

E. 3.3: + All glass (3): 10pcs have no chain only hook  
+ All glass (4): 10pcs have the same length of chain: 15mm

E. 4.4: + All glass (4): 6pcs have the same length of chain: 15mm  
+ All glass (3): 6pcs have no chain only hook

E. 5.5: + All glass (4): 4pcs have the same length of chain: 203mm

After assembling the glasses , be sure match with the attached photo

