



12VDC

NEW!

# RGB Tunable FlexTape®

BALANCE

4.4W/ft.  
(14.4W/m)

Red	Green	Blue
48 Lumens per ft. (157 per meter)	121 Lumens per ft. (397 per meter)	35 Lumens per ft. (115 per meter)



Tresco®'s RGB Balance FlexTape® goes the distance, with 16 million color variations and On-Board Constant Current Regulators creating consistent dramatic lighting is a reality. Created for high-end projects including residential, hospitality and commercial.

### Why Balance

All tape lighting has inherent voltage drop. This voltage drop can cause color shift in longer runs of RGB. The On-Board Constant Current Regulators prevent this from happening resulting in balanced color from start to finish.

### Features:

120° beam angle

4.4W/ft.

Sold in 13' (4 m) roll

Cuttable every 1-5/8" (42 mm)

No soldering required – simple FlexConnect connectors (sold separately)

Precision tunable remote controls (sold separately)

### Typical Applications:

Under Cabinet

Interior Cabinets

Accent Lighting

Displays

Task Lighting

Store fixtures

Toe kick

Soffit

Backlighting



16 million color combinations

Cuttable every 1-5/8" (42 mm)

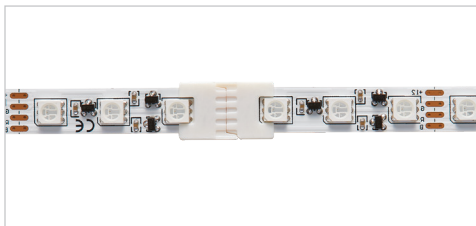

No soldering required – simple FlexConnect connectors (sold separately)



Strong 300 LSE 3M™ adhesive backing



### Dimensions:

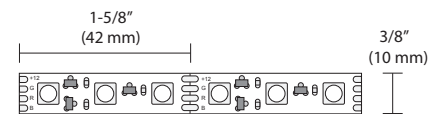
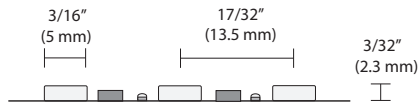

RGB Tunable FlexTape® can be used as a DIY option for flush and recessed Infinix. For other profiles, must be custom ordered.

Typical Setup:

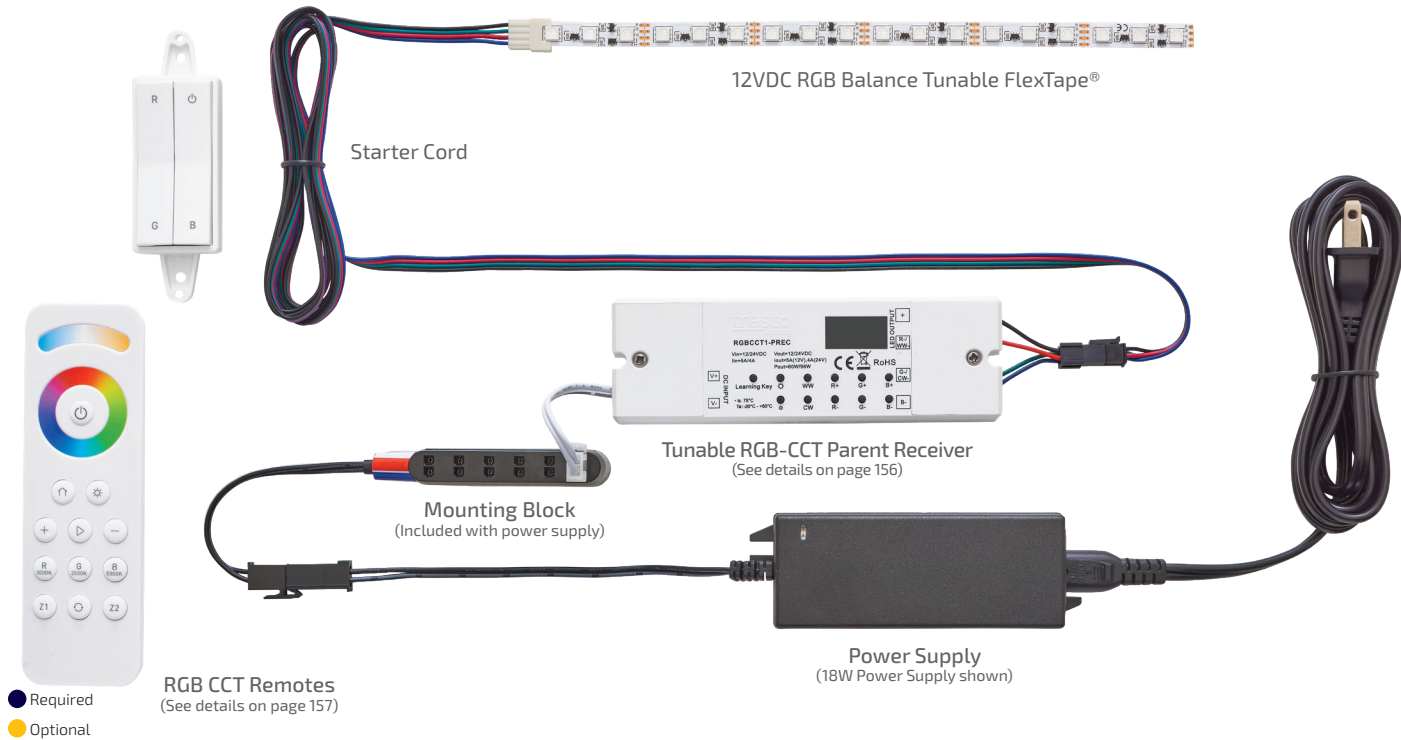

Accessories:

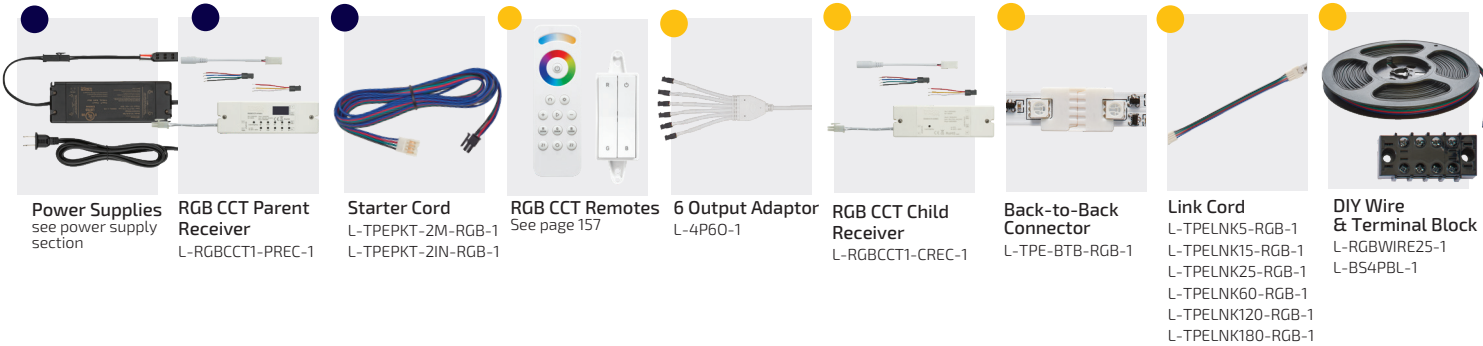

Specifications:

Wattage	Lumens	Input Voltage	Diode Life	Max Per Power Supply 60W	Max Continuous Run	Mounting	Warranty	Beam Angle
4.4W/ft. (14.4W/m)	Red: 48 per ft. (157 per m) Green: 121 per ft. (397 per m) Blue: 35 per ft. (115 per m)	12VDC	50,000 Hours	13' (4 m)	13' (4 m)	Surface	5 Year	

Blue 460 nm    Green 520 nm    Red 630 nm

400    450    500    550    600    650    700    750

Wavelength (nm)

Wavelengths are averages.

## ● 12VDC RGB Tunable FlexTape®

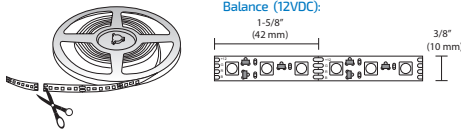

Part #	Description
--------	-------------

L-FLXTPE-12RGB-1	12VDC 4.4W/FT RGB FlexTape W/IC 13' (4 m) Roll
------------------	--

Maximum continuous run is 13' (4 m) for 12VDC and 16.4' (5 m) for 24VDC. Maximum per power supply is 12VDC: 13' (4 m), 24VDC: 16.4' (5 m). Mounts with adhesive backing. Standard 24VDC is cuttable every 2-13/16" (71 mm), RGB Balance 12VDC is cuttable every 1-5/8" (42 mm), RGB Balance 24VDC is cuttable every 3-1/4" (83 mm). To be used on clean, smooth surfaces. Pressure must be applied for proper 3M™ tape adhesion.

## ● 12VDC Power Supplies



Part #	Description
--------	-------------

L-DC-ELT18-CON-1	18W 12VDC Power Supply w/6 Snap Mounting Block*
L-DC-SLELT30-1	30W 12VDC Power Supply w/6 Snap Mounting Block*
L-DC-SLELT60-1	60W 12VDC Power Supply w/6 Snap Mounting Block*
L-DC-ELT6WP-CON-1	6W 12VDC Wall Mount Power Supply w/3 Snap Block*
L-DC-ELT15WP-CON-1	15W 12VDC Wall Mount Power Supply w/6 Snap Block*
L-DC-EQ30-1	30W 12VDC Equiline Power Supply w/6 Snap Block*
L-DC-EQ60-1	60W 12VDC Equiline Power Supply w/6 Snap Block*
L-DCE30D-CON-1	30W 12VDC Hardwire Dimmable LED Power Supply†
L-DCE60D-CON-1	60W 12VDC Hardwire Dimmable LED Power Supply†
L-12DCH60X1-1	60W 12VDC Commercial/Industrial Metal Hardwire Dimmable Power Supply§
L-12DCH60X3-1	180W 12VDC Commercial/Industrial Metal Hardwire Dimmable Power Supply§

\* Dimmable on trailing edge (12VDC side). Mounting block and power cord are included.

† Dimmable by LED line voltage (120V) wall dimmers. Mounting block included.

§ Dimmable by LED line voltage (120V) wall dimmers. Mounting block not included

All hardwire power supplies require an electrician for install.

## ● 12/24VDC RGB Starter Cord

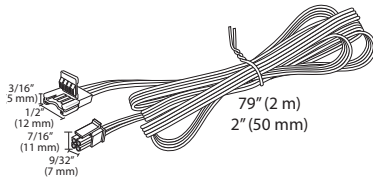

Part #	Description
--------	-------------

L-TPEPKT-2IN-RGB-1	50 mm (2") FlexTape RGB Starter Lead
L-TPEPKT-2M-RGB-1	2 m (79") FlexTape RGB Starter Lead

5/8" (16 mm) hole required.

Maximum linear run of RGB Tunable FlexTape® LED from one starter cord is 16.4' (5 m).

## ● 12/24VDC RGB-CCT Receivers

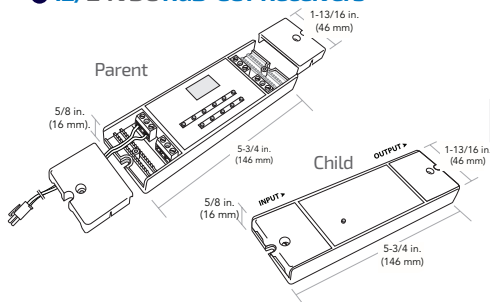

Part #	Description
--------	-------------

L-RGBCCT1-PREC-1	12/24VDC RGBCCT Parent Controller/Receiver
L-RGBCCT1-CREC-1*	12/24VDC RGBCCT Child Controller/Receiver

\*Child Receiver is optional  
6 output adaptor sold separately.

## ● 12/24VDC RGB-CCT Remotes

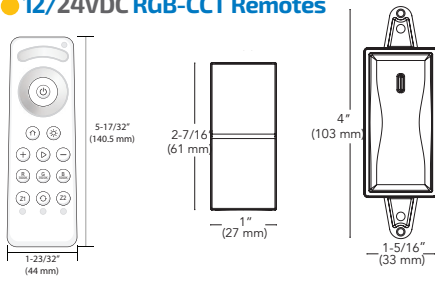

Part #	Description
L-RGBCCT-RMT-1	RGB CCT Wireless Remote
L-WLD-CCT-WH-1	CCT FREEDiM Deco Wall Dimmer White
L-WLD-RGB-WH-1	RGB FREEDiM Deco Wall Dimmer White

## ● 12/24VDC RGB Starter Extension Leads

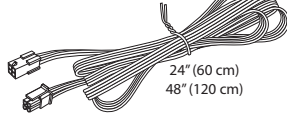

Part #	Description
L-RGBEXT-60-1	60 cm (24") RGB FlexTape Starter Extension Lead
L-RGBEXT-120-1	120 cm (48") RGB FlexTape Starter Extension Lead

## ● 12/24VDC RGB Back-to-Back Connector

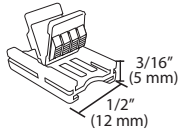

Part #	Description
L-TPE-BTB-RGB-1	RGB FlexTape® Back-to-Back Connector

## ● 12/24VDC 6 Output Adaptor

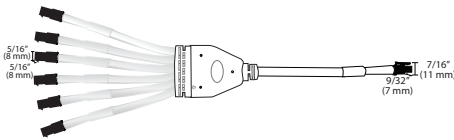

Part #	Description
L-4P60-1	4 Position, 6 Output Adaptor - White

## ● 12/24VDC RGB Link Cord

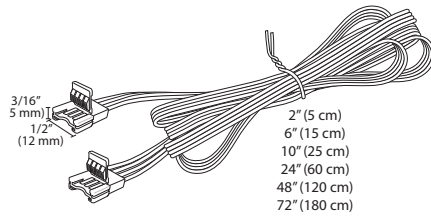

Part #	Description
L-TPELNK5-RGB-1	5 cm (2") RGB FlexTape® Link Cord
L-TPELNK15-RGB-1	15 cm (6") RGB FlexTape® Link Cord
L-TPELNK25-RGB-1	25 cm (10") RGB FlexTape® Link Cord
L-TPELNK60-RGB-1	60 cm (24") RGB FlexTape® Link Cord
L-TPELNK120-RGB-1	120 cm (48") RGB FlexTape® Link Cord
L-TPELNK180-RGB-1	180 cm (72") RGB FlexTape® Link Cord

## ● 12/24VDC RGB DIY

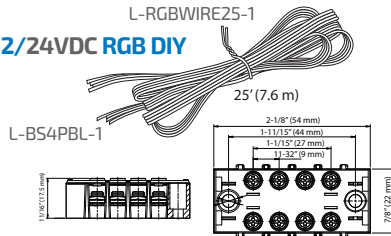

Part #	Description
L-RGBWIRE25-1	25' (7.6 m) 22AWG RGB Wire Roll
L-BS4PBL-1	12/24VDC Barrier Splice 4 Position Black