

Fixtures are classified for insulated ceilings-type IC and type T-and for suspended ceilings-type S. To insure safe and reliable operations. Make sure the fixture corresponds to the carefully before beginning installation

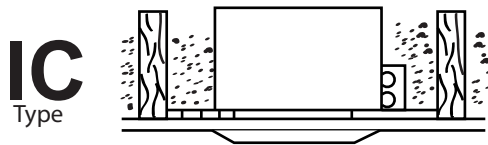

### Insulated Ceiling

The insulated ceiling or I.C. approved recessed fixture is one that can be installed in direct contact with insulation

Before attempting installation of any recessed lighting fixture check your local electrical code. This code sets the wiring standards for your locality and should be carefully studied before starting work

### Airtight installation

This housings certified under ASTM E283 are supplied with a pre-installed gasket or supplied with a ready-to-install self adhesive gasket.

- Step 1. Lay gasket flat and peel protective paper backing from gasket to expose adhesive side.
- Step 2. Apply supplied gasket to ceiling lip and wrap gasket around inside of housing to form seal of the ceiling opening or apply caulk per state / local code. When properly installed, Nora housings provide compliance with restricted air-flow regulations.

## TO INSTALL HOUSING

### Standard Joist Ceilings:

- Use bar hangers to attach fixture between ceiling joists. Each end of the bar hanger is equipped with a nail-in barbed tab. Additional hardware such as screws or nails may be used if extra support is necessary.
- For steel studs, use steel piercing screws in place of nails or barbed tabs.
- Remove shipping screw from underneath side of plaster frame.

### T-Bar Ceilings:

- If mounting to a T-Bar type ceiling, mount fixture onto grid by placing notches on the bottom of each end of the bar hanger over the grid.
- Tie fixture to grid with structural wire going through both the circular knockout on the end of the bar hanger and nearest accompanying knockout on the ceiling grid.

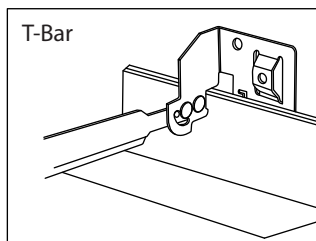
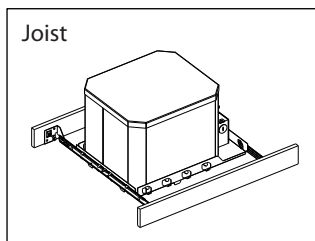

## CUTTING A HOLE

Locate the center of proposed opening on your tile or ceiling material and mark it.

Use a compass to draw a circle shown below diameter around the center point. Cut along this circular line.

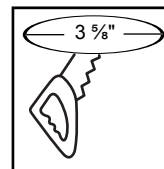

3.5" HOUSING

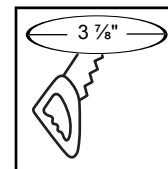

3.7" HOUSING

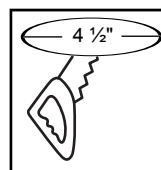

4" HOUSING

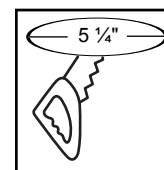

5" HOUSING

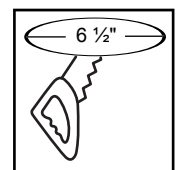

6" HOUSING

## WIRING FOR USING DIMMER

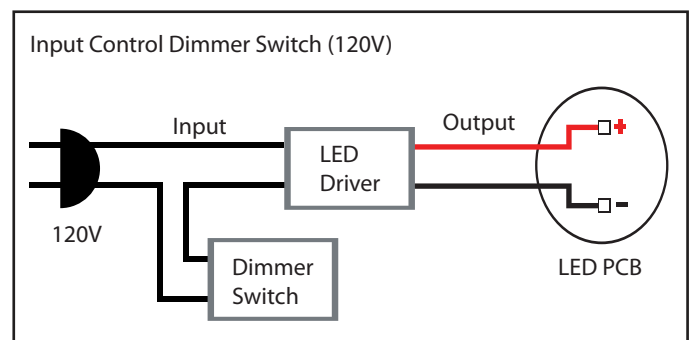

## ELECTRICAL CONNECTION

### Junction Box Wiring

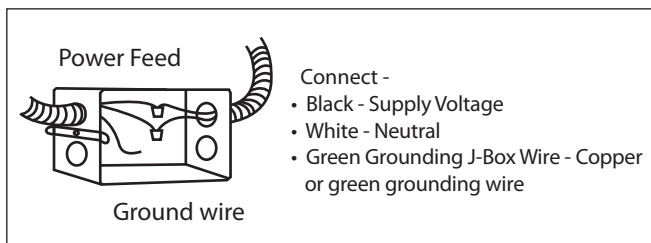

Connect 1/2 inch trade size steel conduit to junction box with appropriate fitting. If using Romex-type shielded wiring, use rectangular pry-out strain reliefs located on upper corners of junction box.

### EXPRESS LIMITED WARRANTY

Subject to the exclusions below, each NICOR LED product, including the LED electronics and components of a property installed NICOR LED product, will be free from defect in materials and workmanship for a period of ve (5) years from the original date of purchase. The product shall be considered defective only if 10% or more of the product's LED components fail. NICOR LED product warranty covers the following performance criteria: LED Light Output will be maintained above 70% of initial output; LED color temperature will not shift more than 200K in CCT; LED driver will operate within NICOR specifications; and the xture nish, excluding natural aluminum or brass products, will not exhibit cracking, peeling, excessive fading, or corrosion during the warranty period. Exceptions apply as dened in NICOR's product specification sheets, which are incorporated by reference herein.

This limited warranty is provided to you, the purchaser of the product identified on Seller's invoice, as your exclusive remedy and applies only to NICOR products that have been purchased from an authorized NICOR Distributor; the product was new and in an unopened NICOR package at the time of installation; and the NICOR product was installed by a licensed electrician or under the supervision of a licensed electrician and used by consumers in the United States or Canada when accompanied with this warranty. This warranty extends only to the rst consumer purchaser and is not transferable. A consumer wishing to invoke the terms of this limited warranty must rst obtain a RGA number within 30 days of discovery of the defect, and return the product to NICOR for inspection. Once veried to be covered by this limited warranty, NICOR will, at its sole discretion, repair, replace, or refund the purchase price of any product that does not conform to this limited warranty. If NICOR, at its sole discretion, determines that the product should be repaired or replaced, this warranty is limited to the reasonable, customary, and necessary costs and expenses associated with the repair/replacement. This warranty requires that all repair/replacement estimates and costs, including but not limited to equipment rental (if any), and any other cost or expense to be incurred in the repair/replacement of the product, be approved in advance and in writing by NICOR. FAILURE TO OBTAIN NICOR'S ADVANCE WRITTEN APPROVAL OF ALL REPAIR/REPLACEMENT COSTS AND EXPENSES IN WRITING SHALL VOID THIS LIMITED WARRANTY.

### THIS LIMITED WARRANTY DOES NOT COVER THE FOLLOWING:

- Defects or damages resulting from improper installation, operation, storage, misuse or abuse, accident, or neglect;
- Defects or damages resulting from improper service, testing, adjustment, installation, maintenance, alteration, connection to out-of-speciation electrical service, corrosive or damp environments, or connection to incompatible equipment or devices (e.g., connecting non-dimmable lighting products to dimmers);
- Damage which occurs in transit;
- Power surges or overheating due to external conditions
- Acts of nature including but not limited to lightning strikes

ANY IMPLIED WARRANTIES, INCLUDING WITHOUT LIMITATION, THE IMPLIED WARRANTIES OF MERCHANTABILITY AND FITNESS FOR A PARTICULAR PURPOSE SHALL BE LIMITED TO THE DURATION OF THIS LIMITED WARRANTY, OTHERWISE THE REPAIR, REPLACEMENT, OR REFUND AS PROVIDED UNDER THIS EXPRESS LIMITED WARRANTY IS THE EXCLUSIVE REMEDY OF THE CONSUMER, AND IS PROVIDED IN LIEU OF ALL OTHER WARRANTIES, EXPRESS OR IMPLIED. IN NO EVENT SHALL NICOR BE LIABLE, WHETHER IN CONTRACT OR IN TORT (INCLUDING NEGLIGENCE) FOR DAMAGES IN EXCESS OF THE PURCHASE PRICE OF THE PRODUCT, OR FOR ANY INDIRECT, INCIDENTAL, SPECIAL OR CONSEQUENTIAL DAMAGES OF ANY KIND, OR LOSS OF REVENUE OR PROFITS, LOSS OF BUSINESS OR OTHER FINANCIAL LOSS ARISING OUT OF OR IN CONNECTION WITH THE ABILITY OR INABILITY TO USE THE PRODUCT TO THE FULL EXTENT THESE

DAMAGES MAY BE DISCLAIMED BY LAW.

# THANK YOU FOR YOUR PURCHASE

SHARE YOUR EXPERIENCE WITH US

SCAN the QR or visit

[www.nicorlighting.com/support/survey](http://www.nicorlighting.com/support/survey)

FOLLOW US



YouTube

